

Frame 96462

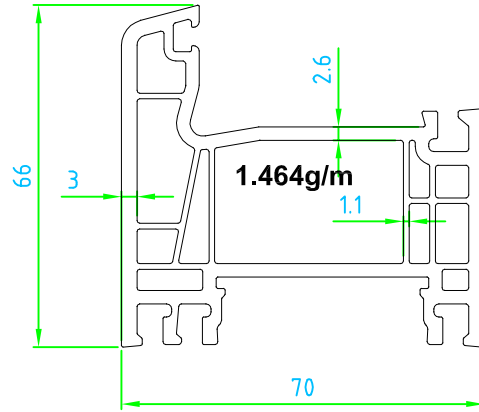

Sash 78 96465

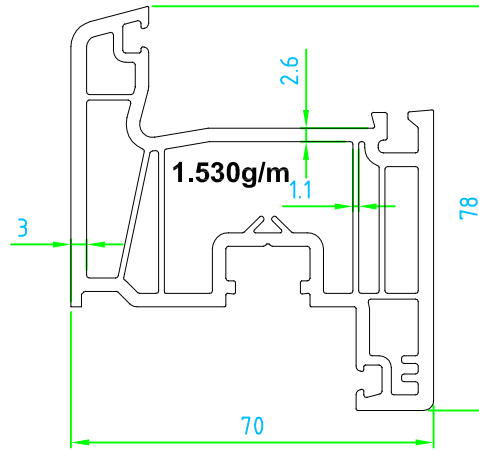

Mullion 82 96553

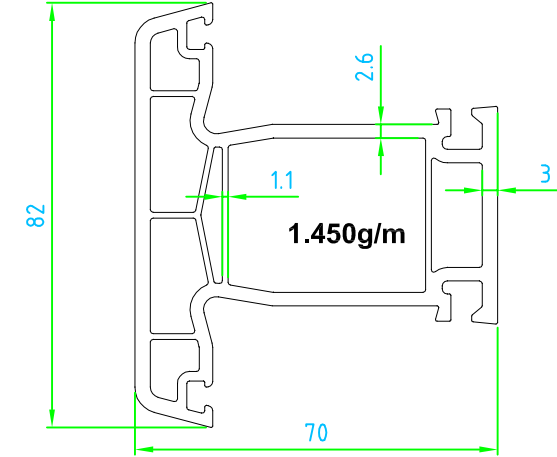

Door Sash 96555

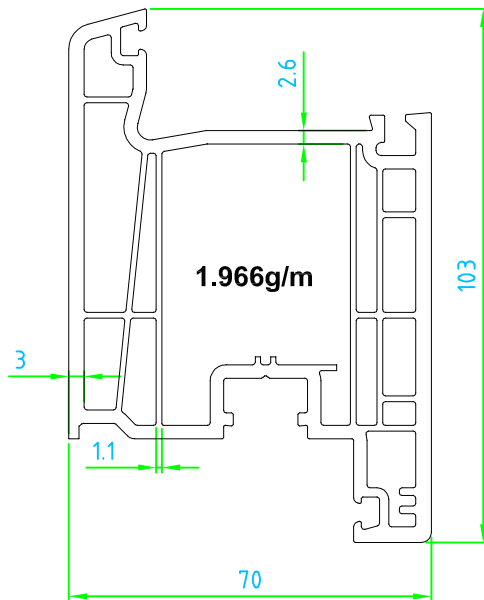

Frame extension 40 96613

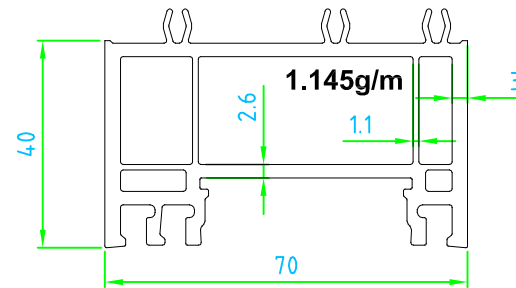

Glass bead 13 96289

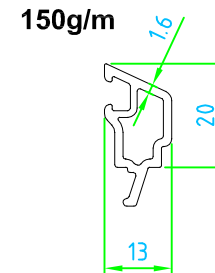

Glass bead 20 96487

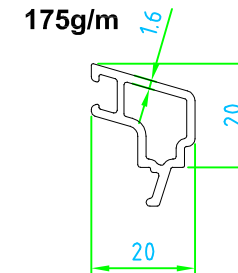

Glass bead 20 Baroque 96488

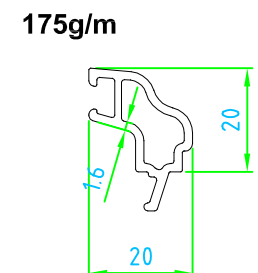

e-mail: office@extrunet.com
tel.: +43(0)570 580 2
fax: +43(0)570 580 923

extrunet GmbH 
Bad Haller Str. 40 A-4550 Kremsmünster



gezeichnet	Datum	Name/DW
	13.12.2016	MoDi

Maßstab	Reck 5-chamber 70mm
1:5:1	

Zeichnungs - Nr.	Uebersicht02b
------------------	---------------

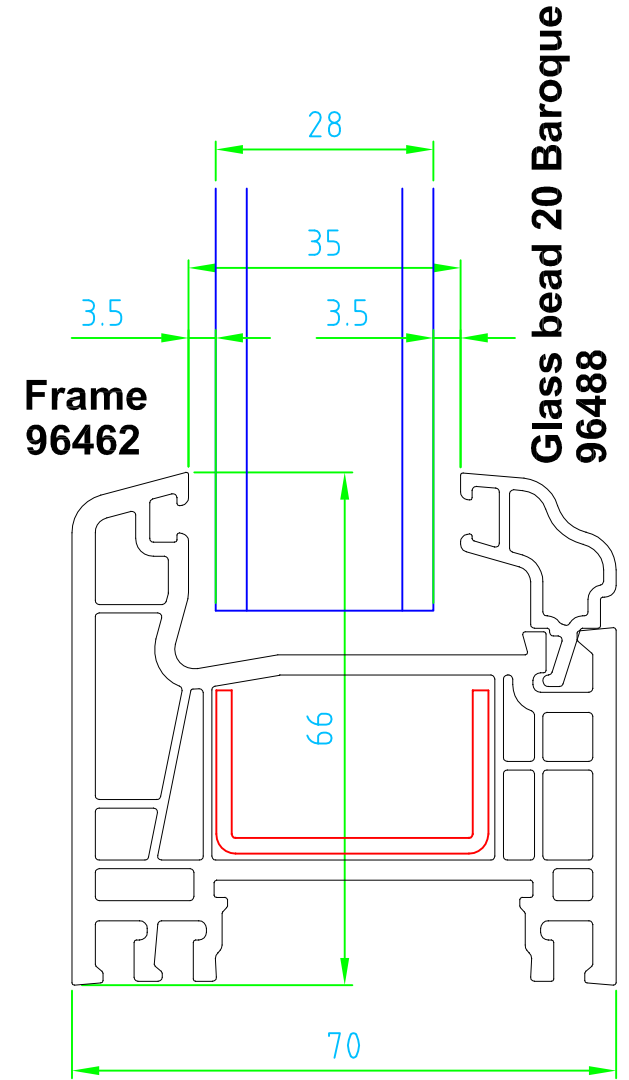
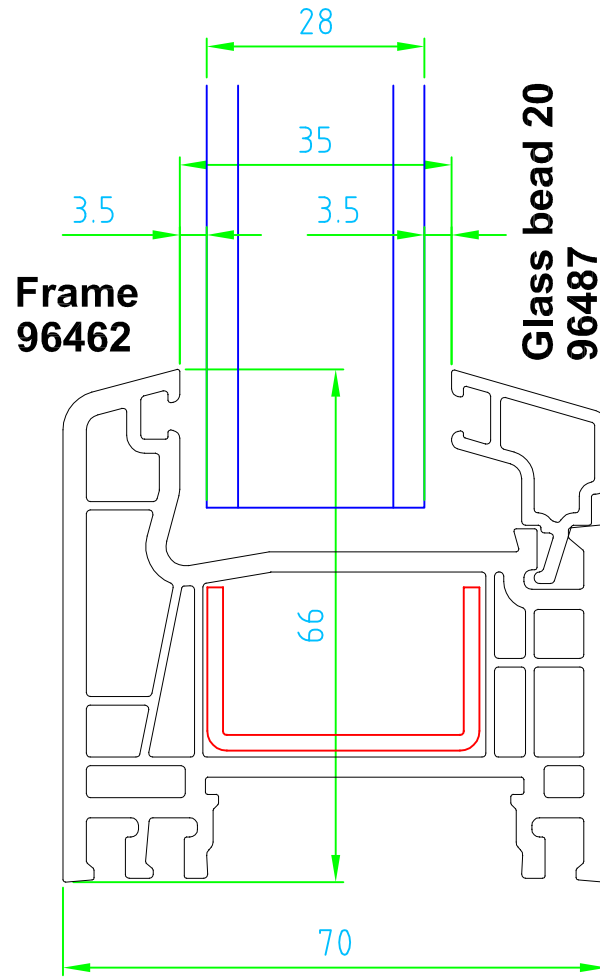
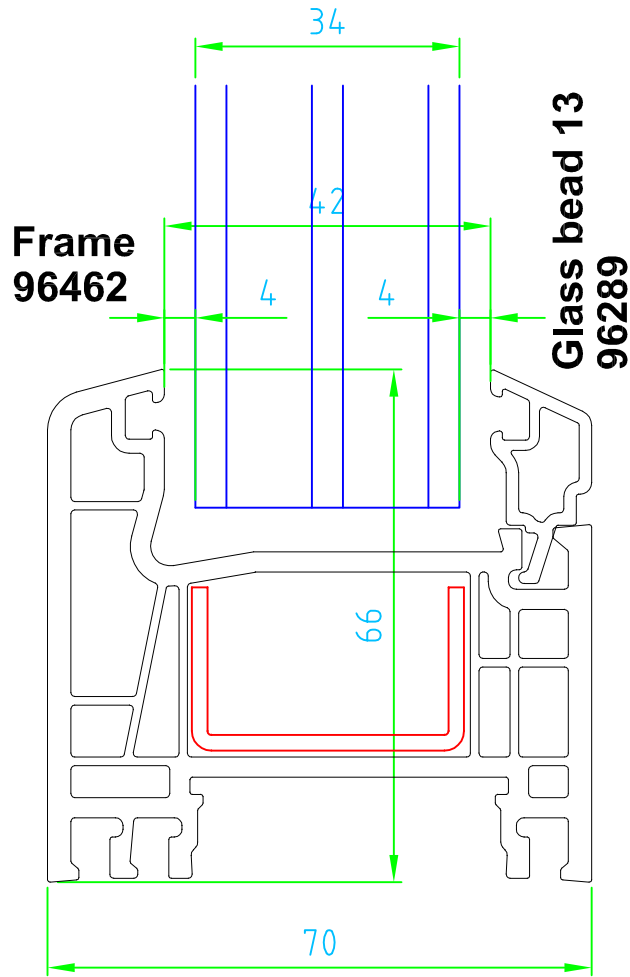
Lage	Toleranzen	Oberfläche	Werkstoff	Type / Kurzzeichen / Auftragsnummer
			PVC	



e-mail: office@extrunet.com		extrunet GmbH  Bad Haller Str. 40 A-4550 Kremsmünster	
tel.: +43(0)570 580 2			
fax: +43(0)570 580 923			
gezeichnet	Datum	Name/DW	Zeichnungs - Nr.
	13.12.2016	MoDi	
Maßstab	Reck 5-Kammer 70mm		Type / Kurzzeichen / Auftragsnummer
1:5:1			
Lage	Toleranzen	Oberfläche	Werkstoff
			PVC

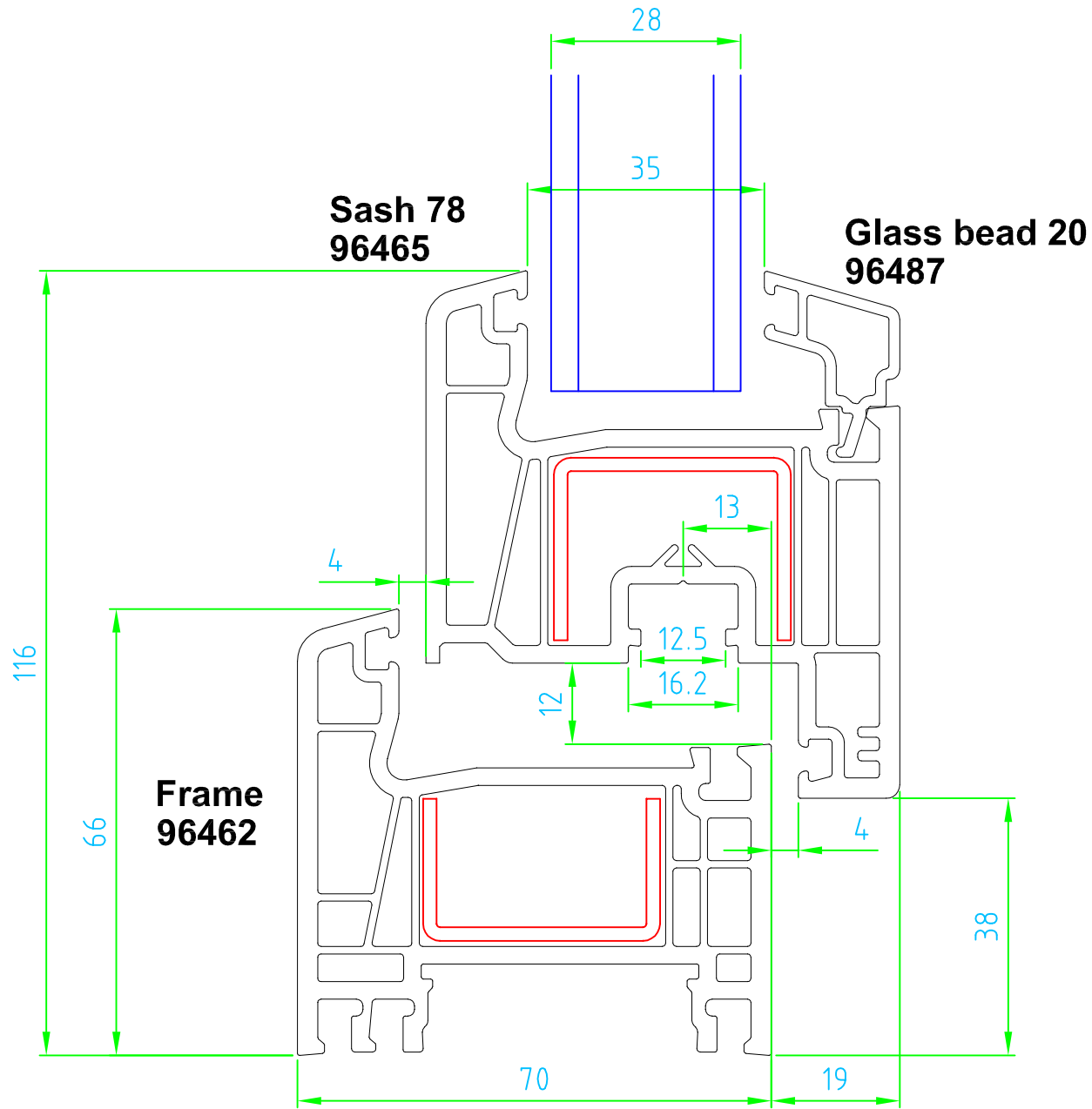

e-mail: office@extrunet.com
 tel.: +43(0)570 580 2
 fax: +43(0)570 580 923

extrunet GmbH 
 Bad Haller Str. 40 A-4550 Kremsmünster

gezeichnet	Datum	Name/DW
	05.12.2016	MoDi

Maßstab	Reck 5-Kammer 70mm
1:5:1	

Zeichnungs - Nr.
Uebersicht02a

Lage	Toleranzen	Oberfläche	Werkstoff	Type / Kurzzeichen / Auftragsnummer
			PVC	

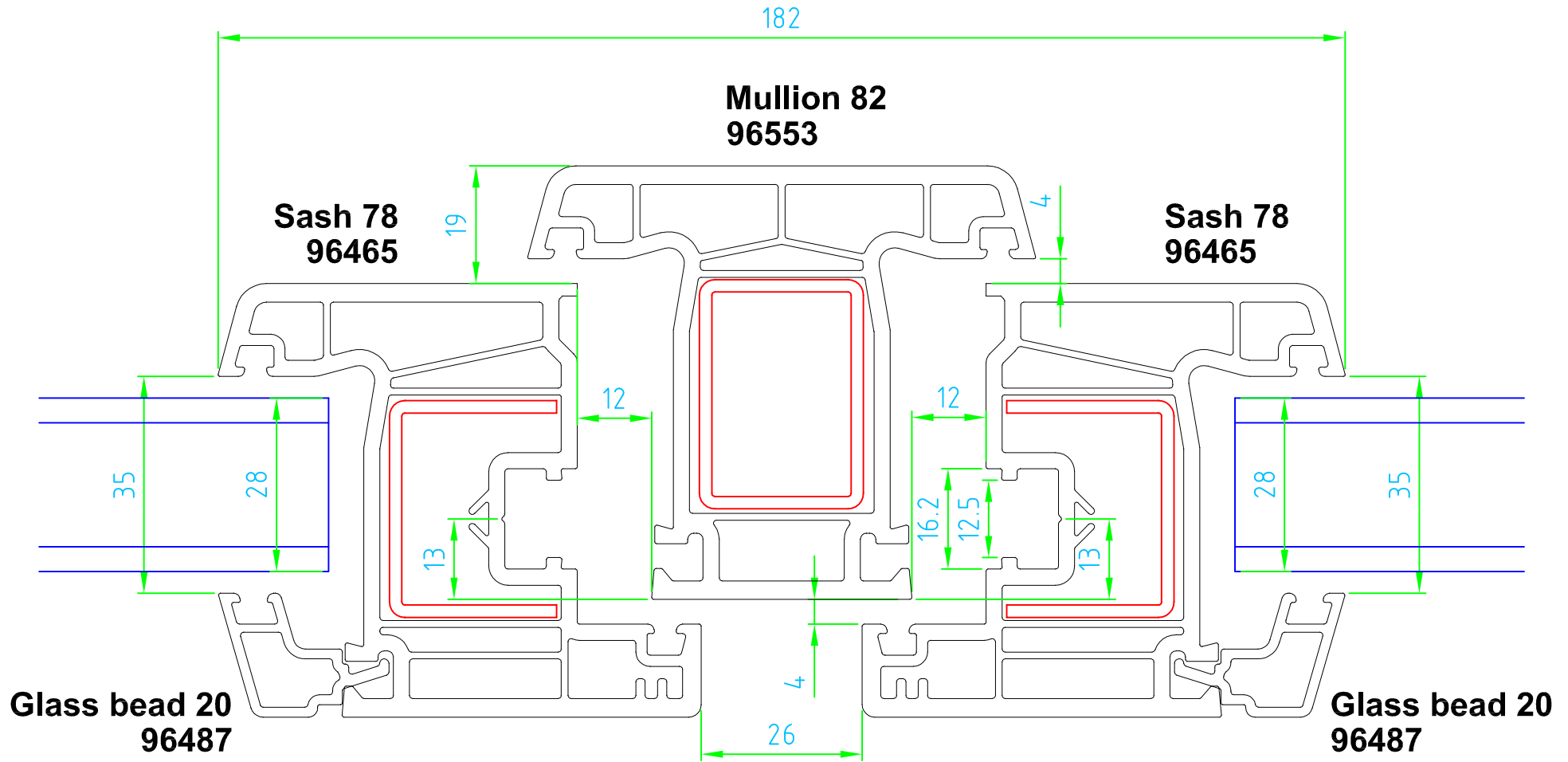

e-mail: office@extrunet.com
 tel.: +43(0)570 580 2
 fax: +43(0)570 580 923

extrunet GmbH 
 Bad Haller Str. 40 A-4550 Kremsmünster

gezeichnet	Datum	Name/DW	Zeichnungs - Nr. Uebersicht02a	
	05.12.2016	MoDi		
Maßstab	Reck 5-Kammer 70mm		Type / Kurzzeichen / Auftragsnummer	
1:5:1				
Lage	Toleranzen	Oberfläche	Werkstoff	
			PVC	

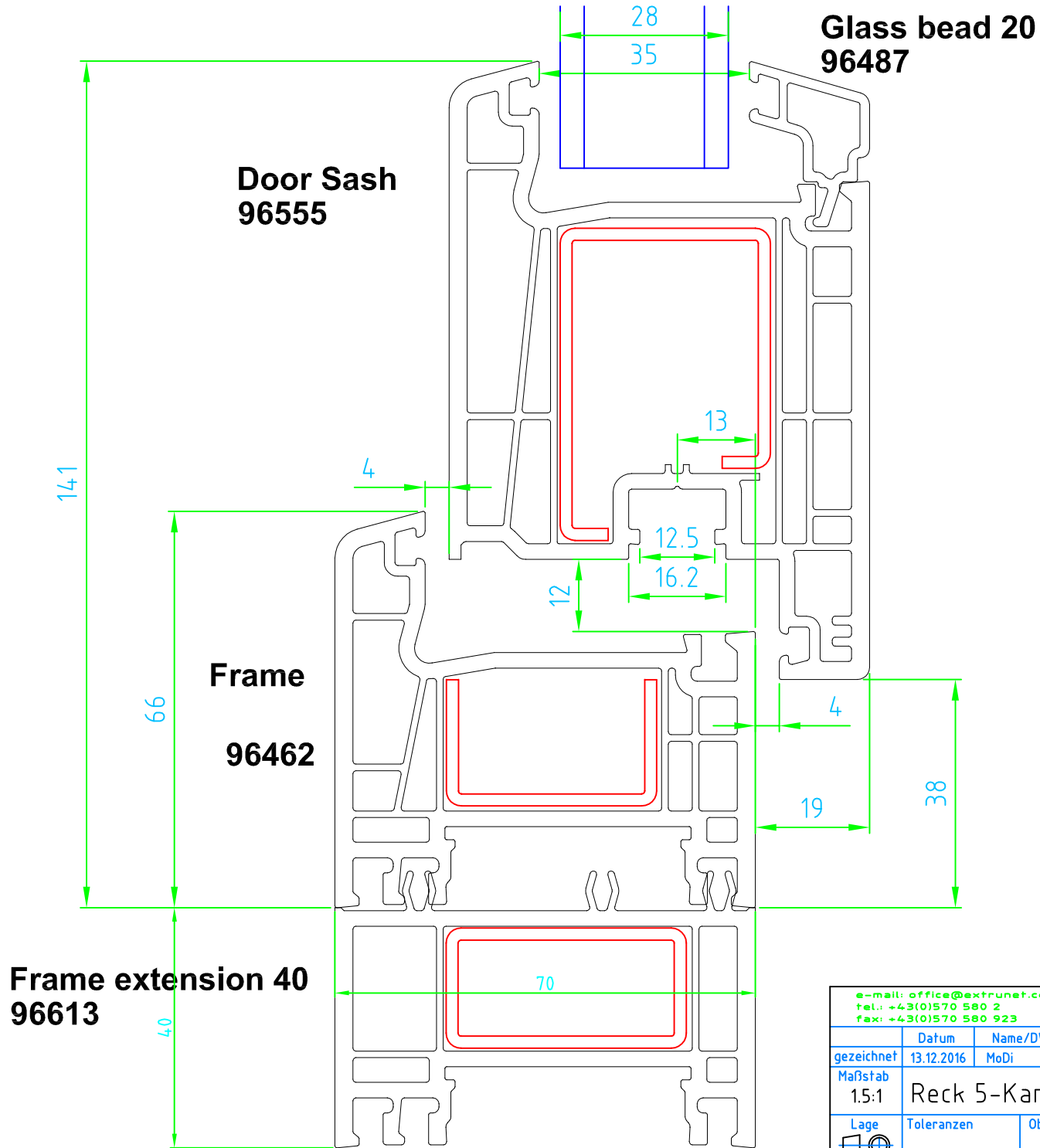

e-mail: office@extrunet.com
 tel.: +43(0)570 580 2
 fax: +43(0)570 580 923

extrunet GmbH 

Bad Haller Str. 40 A-4550 Kremsmünster

gezeichnet	Datum	Name/DW
	13.12.2016	MoDi

Maßstab
1.5:1

Reck 5-Kammer 70mm

Zeichnungs - Nr.
Uebersicht02b

Lage 

Toleranzen

Oberfläche

Type / Kurzzeichen / Auftragsnummer

Werkstoff
PVC